

BIRD WITH POCKETS

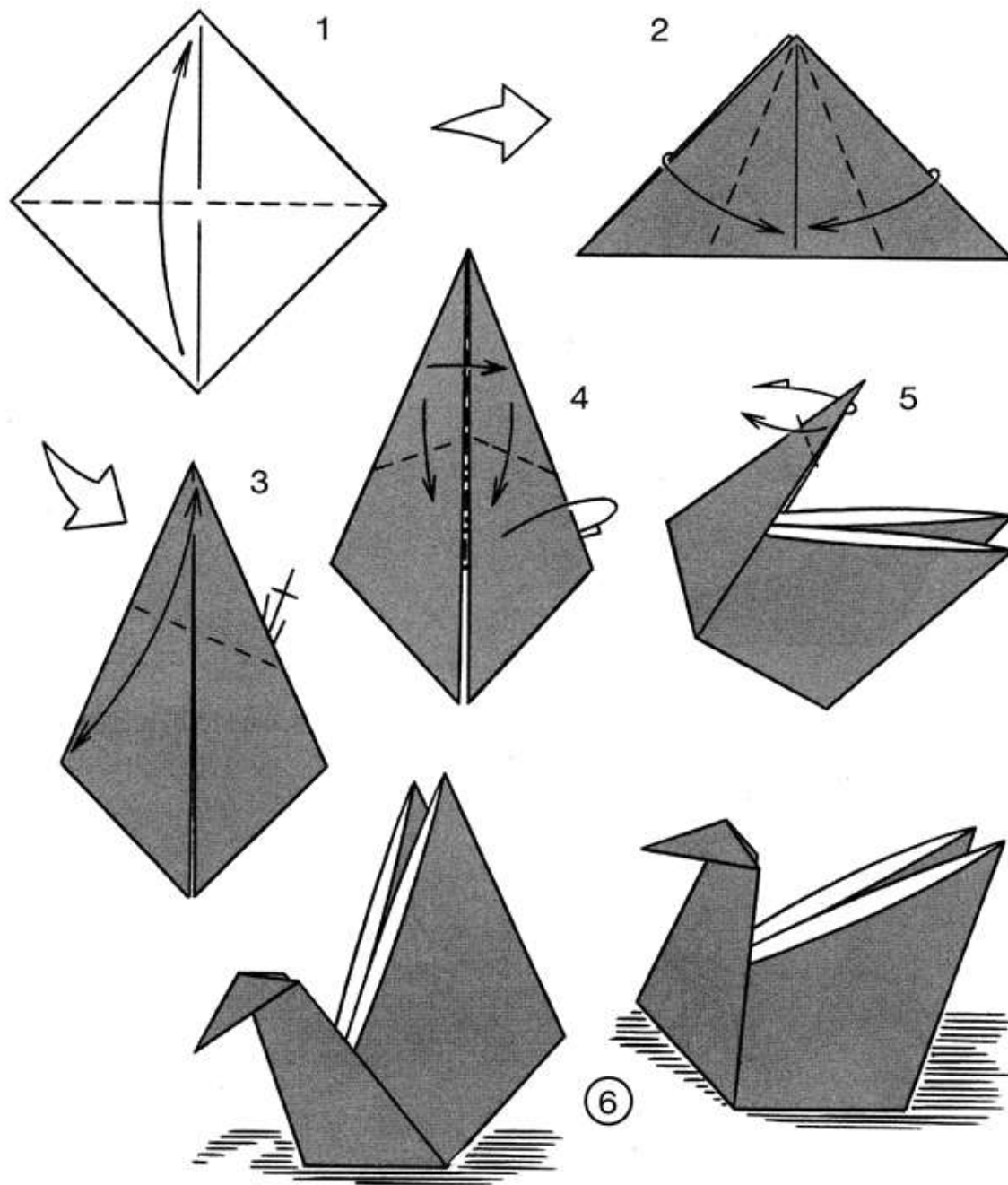

KΥΚΝΟΣ

HOW TO FOLD A SQUARE SHEET IN HALF

1. Place the two lower corners precisely over the two upper corners.

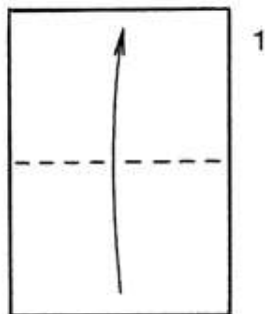

2. Hold down the top of the paper firmly with one hand while you move the other hand down the right side, pressing the paper from top to bottom.

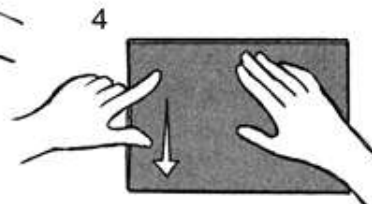
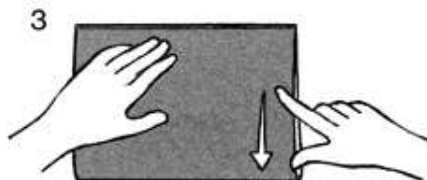

3. Repeat the procedure on the left side.

You must fold correctly in order to make good origami.

Some beginners do not stop to think about this process and fold the paper this way:

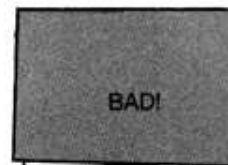

ΔΙΠΛΩΜΑ
ΧΑΡΤΙΟΥ

CAP

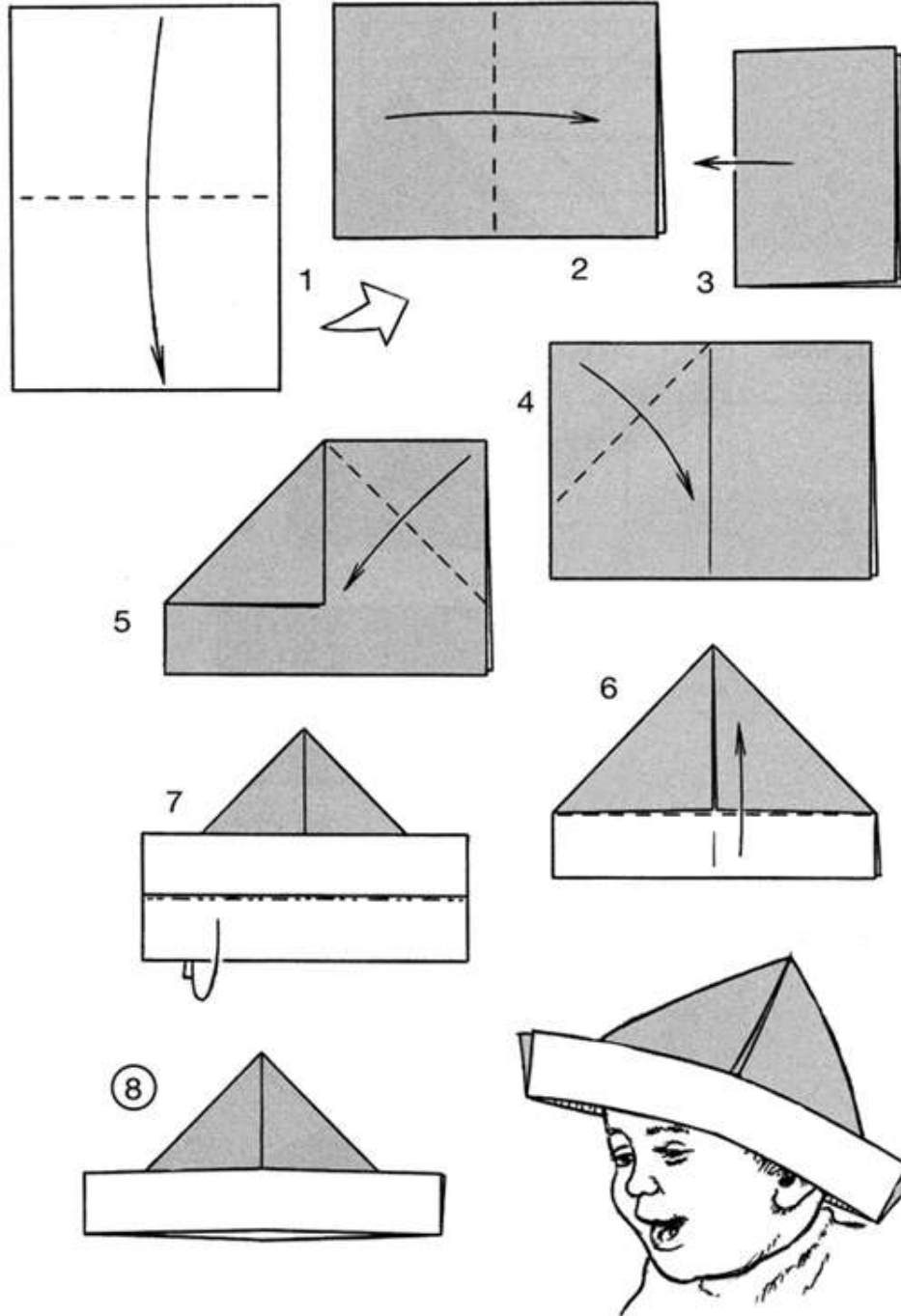

ПОТІРІ

Boat

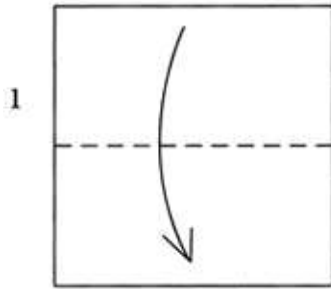

Fold in half.

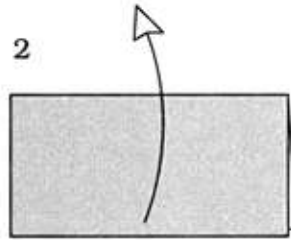

Unfold.

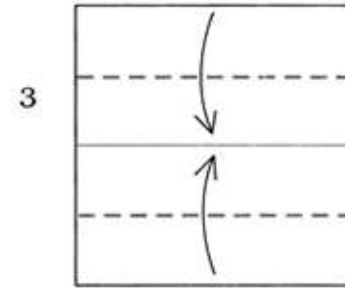

Fold to the center.

KAPABAKI

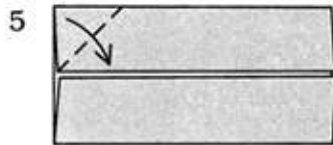

Fold a corner towards the center.

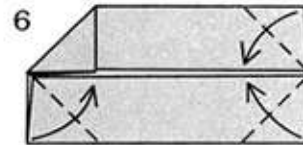

Fold the other corners towards the center.

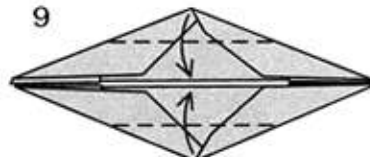
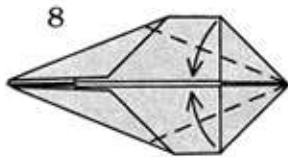
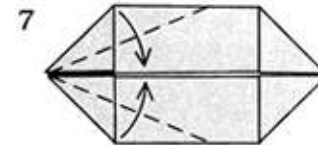

Fold to the center.

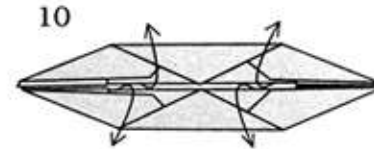

Open up to see the white paper.

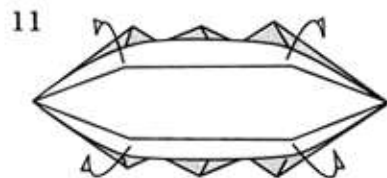

Fold inside-out and turn over.

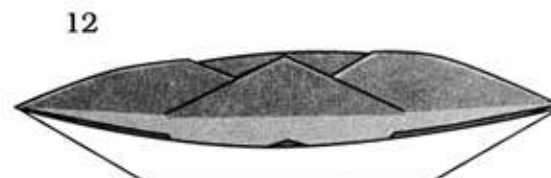

Boat

10

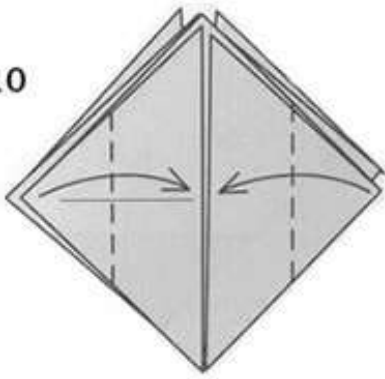

Fold to the center, repeat behind.

11

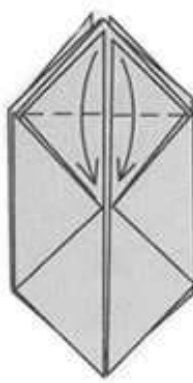

Fold to the center, repeat behind.

12



Repeat behind.

ΝΕΡΟΜΠΟΜΠΑ

13



Unfold, repeat behind.

14

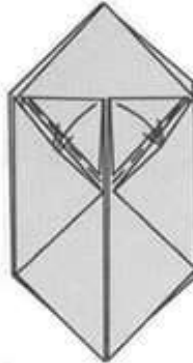

Tuck inside the pockets, repeat behind.

15

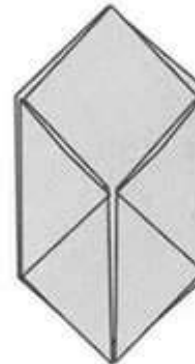

Blow into the bottom.

16

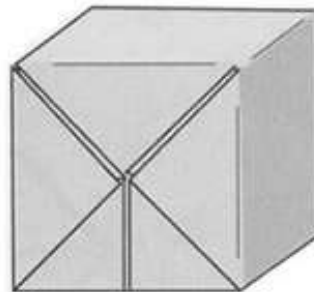

Waterbomb

Cup

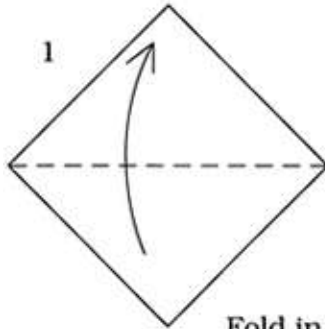

Fold in half.

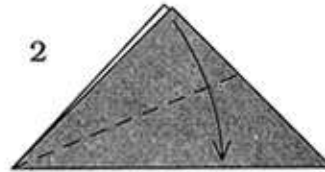

Fold one side down.

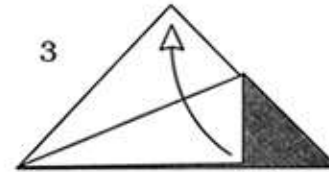

Unfold.

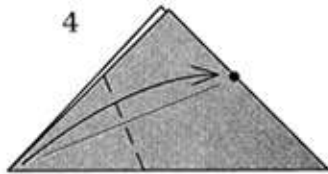

Fold the corner to the dot.

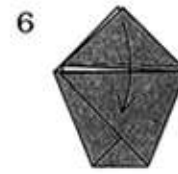
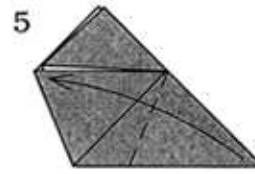

Fold one layer down.

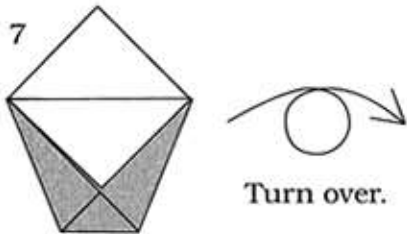

Turn over.

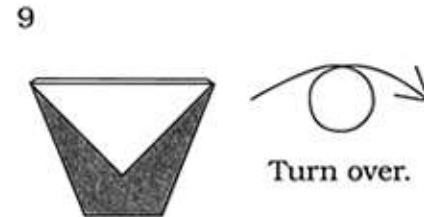
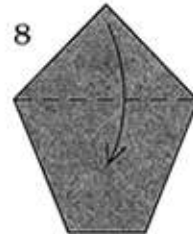

Turn over.

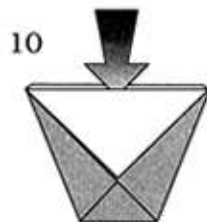

Place your finger inside to open the cup.



Cup

Tulip

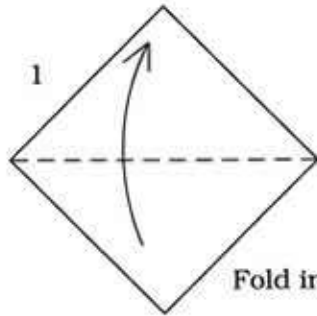

Fold in half.

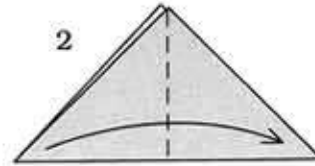

Fold in half.

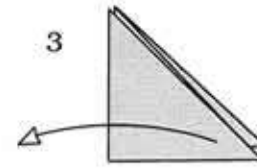

Unfold.

ΤΟΥΛΙΠΑ

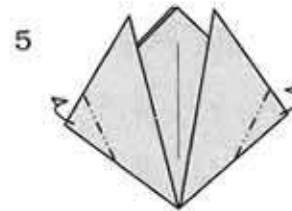
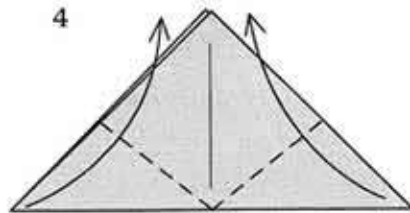

Fold behind.

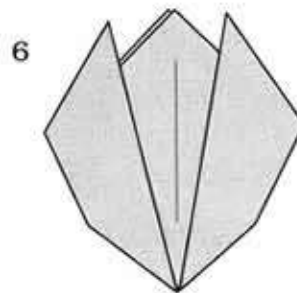

Tulip